

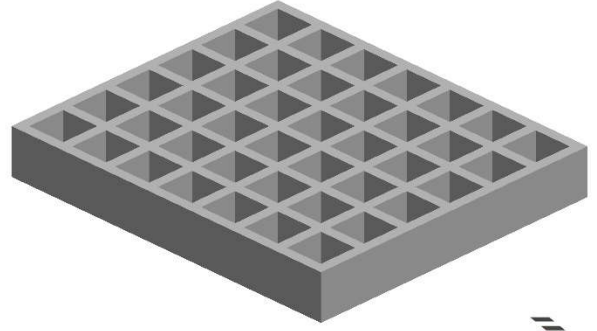

ÜRÜN ADI	CTP KOMPOZİT IZGARA			ÜRÜN KODU			STC-GRD-19x30	
SINIF	AĞIRLIK (kg)	A (mm)	B (mm)	AÇIK ALAN	H (mm)	T1 (mm)	T2 (mm)	
A15	18.5 kg/m ²	19	19	%42	30	5	6.5	
B125	18.5 kg/m ²	19	19	%42	30	5	6,5	

TEKNİK RESİM STC-GRD-19x30

STANDART PLAKA ÖLÇÜSÜ 1000x4040mm

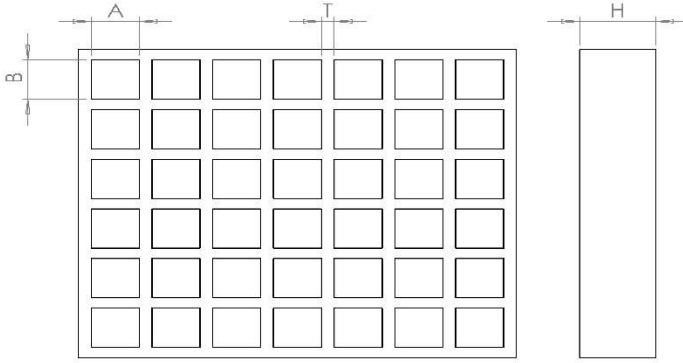

ÜRÜN ADI	CTP KOMPOZİT IZGARA			ÜRÜN KODU			STC-GRD-19x38	
SINIF	AĞIRLIK (kg)	A (mm)	B (mm)	AÇIK ALAN	H (mm)	T1 (mm)	T2 (mm)	
A15	21 kg/m ²	19	19	%44	38	5	6.5	
B125	21 kg/m ²	19	19	%44	38	5	6,5	

TEKNİK RESİM STC-GRD-19x38

STANDART PLAKA ÖLÇÜSÜ 1000x4040mm

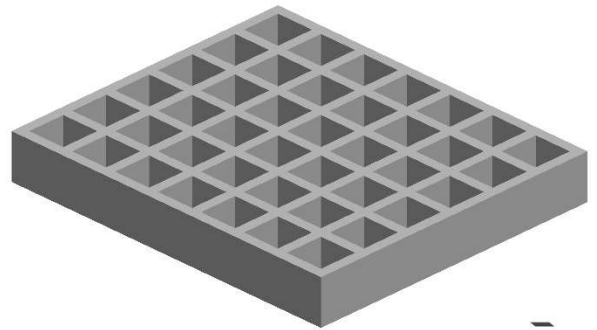
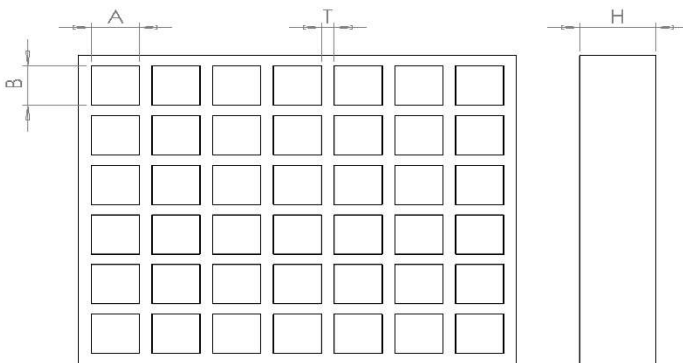

Copyright © 2024 Steecorp Inc. All rights reserved

This technical drawing is protected by copyright law. Reproduction, distribution, or modification of this drawing without the express written permission of the copyright owner is strictly prohibited. Unauthorized reproduction of this drawing may result in civil and/or criminal liability, including fines and imprisonment.

ÜRÜN ADI	CTP KOMPOZİT IZGARA			ÜRÜN KODU			STC-GRD-38x25	
SINIF	AĞIRLIK (kg)	A (mm)	B (mm)	AÇIK ALAN	H (mm)	T1 (mm)	T2 (mm)	
A15	12.5 kg/m ²	38	38	%68	25	5	6.5	
B125	12.5 kg/m ²	38	38	%68	25	5	6.5	

TEKNİK RESİM STC-GRD-38x25

STANDART PLAKA ÖLÇÜSÜ 1000x4040 mm

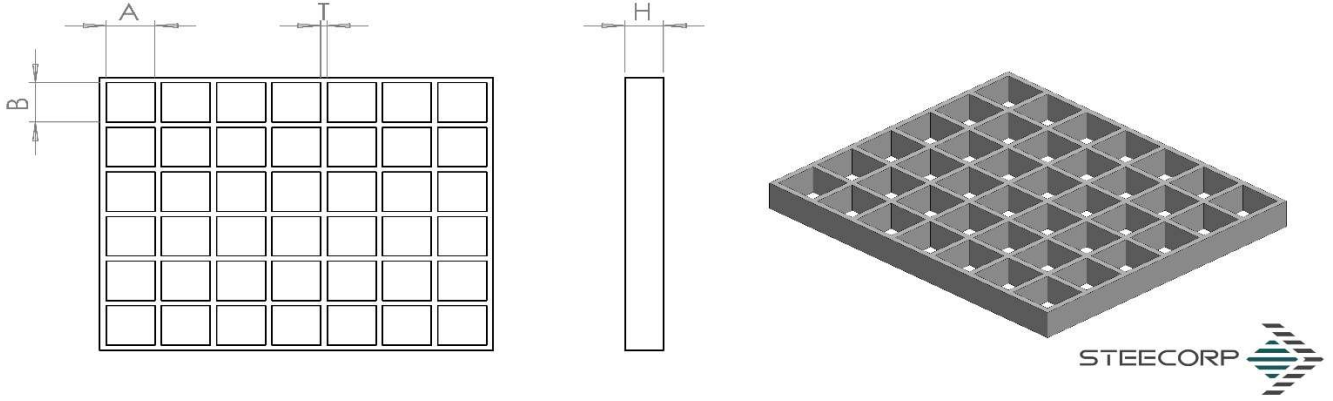

ÜRÜN ADI	CTP KOMPOZİT IZGARA			ÜRÜN KODU			STC-GRD-38x30	
SINIF	AĞIRLIK (kg)	A (mm)	B (mm)	AÇIK ALAN	H (mm)	T1 (mm)	T2 (mm)	
A15	14 kg/m ²	38	38	%68	30	5	6.5	
B125	14 kg/m ²	38	38	%68	30	5	6.5	

TEKNİK RESİM STC-GRD-38x30

STANDART PLAKA ÖLÇÜSÜ 1000x4040 mm

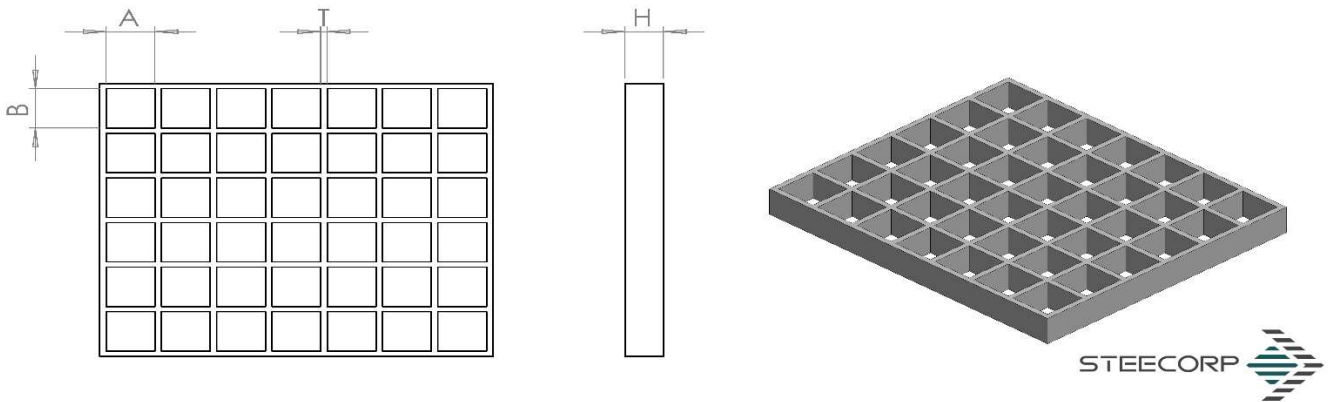

Copyright © 2024 Steecorp Inc. All rights reserved

This technical drawing is protected by copyright law. Reproduction, distribution, or modification of this drawing without the express written permission of the copyright owner is strictly prohibited. Unauthorized reproduction of this drawing may result in civil and/or criminal liability, including fines and imprisonment.

ÜRÜN ADI	CTP KOMPOZİT IZGARA			ÜRÜN KODU			STC-GRD-38x38	
SINIF	AĞIRLIK (kg)	A (mm)	B (mm)	AÇIK ALAN	H (mm)	T1 (mm)	T2 (mm)	
A15	18.5 kg/m ²	38	38	%68	38	5	6.5	
B125	18.5 kg/m ²	38	38	%68	38	5	6.5	

TEKNİK RESİM STC-GRD-38x38

STANDART PLAKA ÖLÇÜSÜ 1220x3660, 1000x3000, 1000x4040 mm

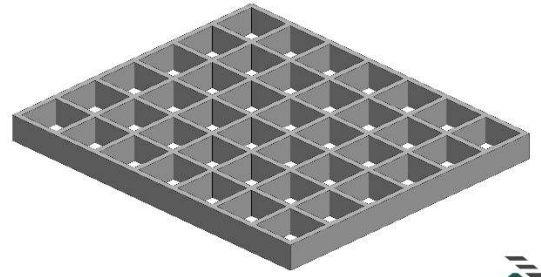
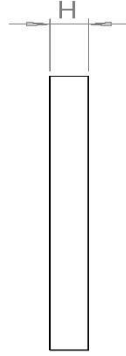
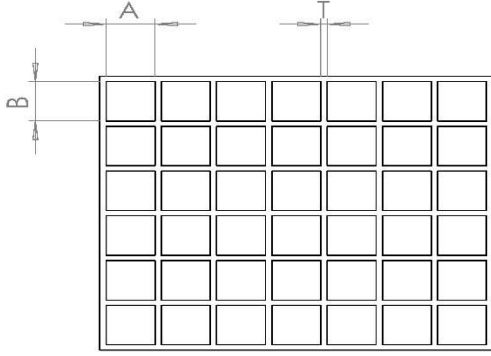

ÜRÜN ADI	CTP KOMPOZİT IZGARA			ÜRÜN KODU			STC-GRD-38x50	
SINIF	AĞIRLIK (kg)	A (mm)	B (mm)	AÇIK ALAN	H (mm)	T1 (mm)	T2 (mm)	
A15	36 kg/m ²	38	38	%74	50	8	11	
B125	36 kg/m ²	38	38	%74	50	8	11	

TEKNİK RESİM STC-GRD-38x50

Standart Panel Ölçüsü: 1000x4040 mm

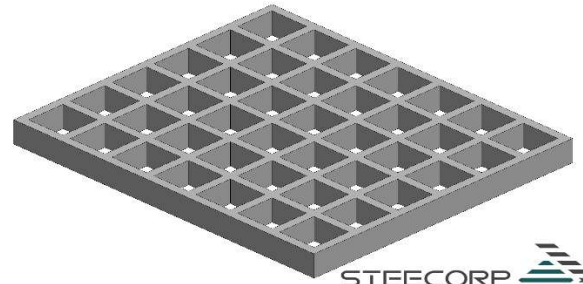
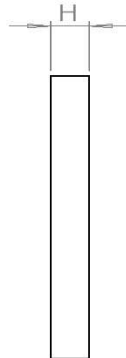
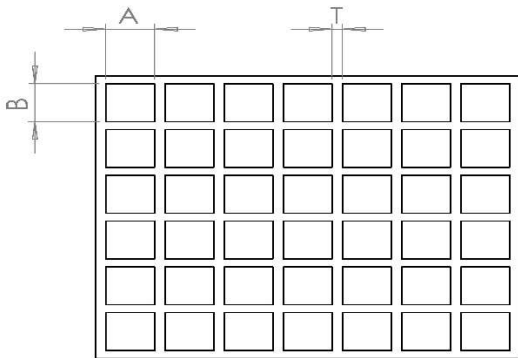

Copyright © 2024 Steecorp Inc. All rights reserved

This technical drawing is protected by copyright law. Reproduction, distribution, or modification of this drawing without the express written permission of the copyright owner is strictly prohibited. Unauthorized reproduction of this drawing may result in civil and/or criminal liability, including fines and imprisonment.

ÜRÜN ADI	CTP KOMPOZİT IZGARA			ÜRÜN KODU			STC-GRD-50x13	
SINIF	AĞIRLIK (kg)	A (mm)	B (mm)	AÇIK ALAN	H (mm)	T1 (mm)	T2 (mm)	
A15	5 kg/m ²	50	50	%72	13	5	6.5	
B125	5 kg/m ²	50	50	%72	13	5	6.5	

TEKNİK RESİM STC-GRD-50x13

Standart Panel Ölçüsü: 1025x4028 mm

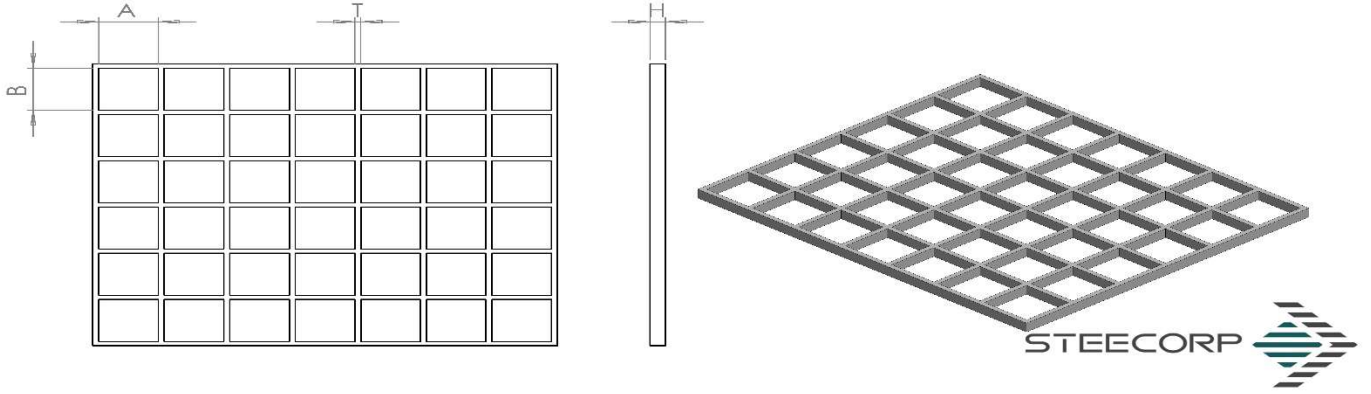

ÜRÜN ADI	CTP KOMPOZİT IZGARA			ÜRÜN KODU			STC-GRD-50x25x50	
SINIF	AĞIRLIK (kg)	A (mm)	B (mm)	AÇIK ALAN	H (mm)	T1 (mm)	T2 (mm)	
A15	44 kg/m ²	50	25	%75	50	9	11	
B125	44 kg/m ²	50	25	%75	50	9	11	

TEKNİK RESİM STC-GRD-50X25X50

Standart Panel Ölçüsü: 1220 x 2030 mm

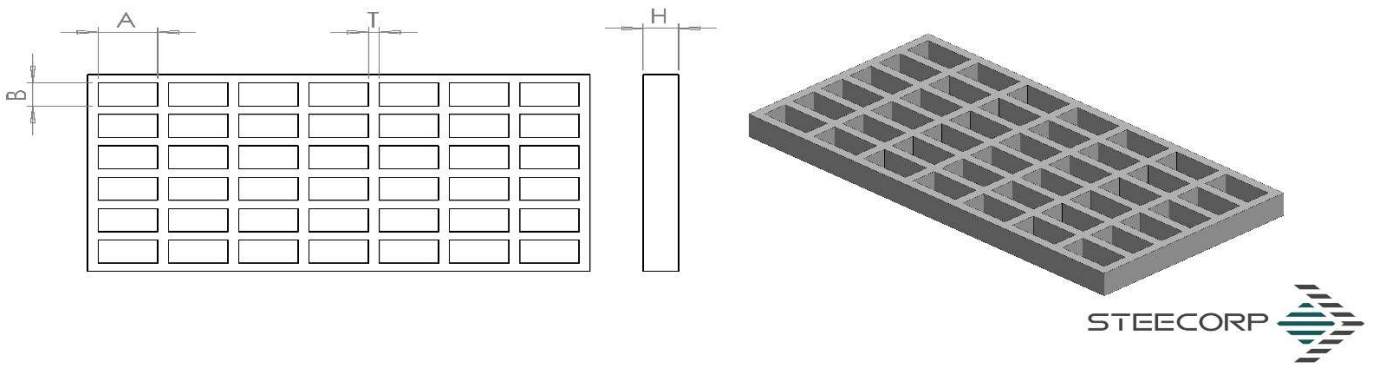

Copyright © 2024 Steecorp Inc. All rights reserved

This technical drawing is protected by copyright law. Reproduction, distribution, or modification of this drawing without the express written permission of the copyright owner is strictly prohibited. Unauthorized reproduction of this drawing may result in civil and/or criminal liability, including fines and imprisonment.

ÜRÜN ADI	CTP KOMPOZİT IZGARA			ÜRÜN KODU			STC-GRD-100x25x38	
SINIF	AĞIRLIK (kg)	A (mm)	B (mm)	AÇIK ALAN	H (mm)	T1 (mm)	T2 (mm)	
A15	20 kg/m ²	100	25	%75	38	5	6.5	
B125	20 kg/m ²	100	25	%75	38	5	6.5	

TEKNİK RESİM STC-GRD-100x25x38

Standart Panel Ölçüsü: 1000 x 4038 mm

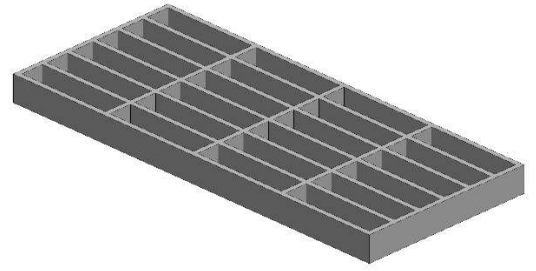
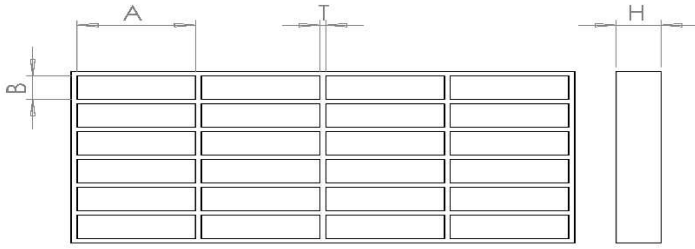

ÜRÜN ADI	M TİPİ BAĞLANTI APARATI	ÜRÜN KODU	STC-GRD-M
----------	-------------------------	-----------	-----------

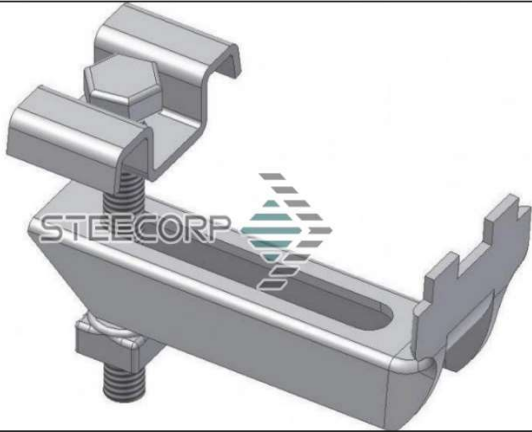
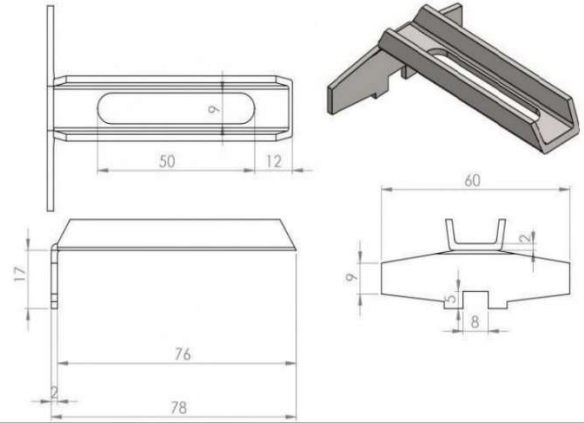
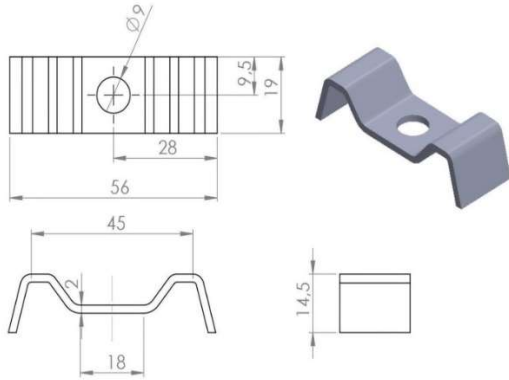

Copyright © 2024 Steecorp Inc. All rights reserved

This technical drawing is protected by copyright law. Reproduction, distribution, or modification of this drawing without the express written permission of the copyright owner is strictly prohibited. Unauthorized reproduction of this drawing may result in civil and/or criminal liability, including fines and imprisonment.